

Especificações Técnicas

TEMPO DE EVACUAÇÃO x DEPRESSÃO DO VÁCUO

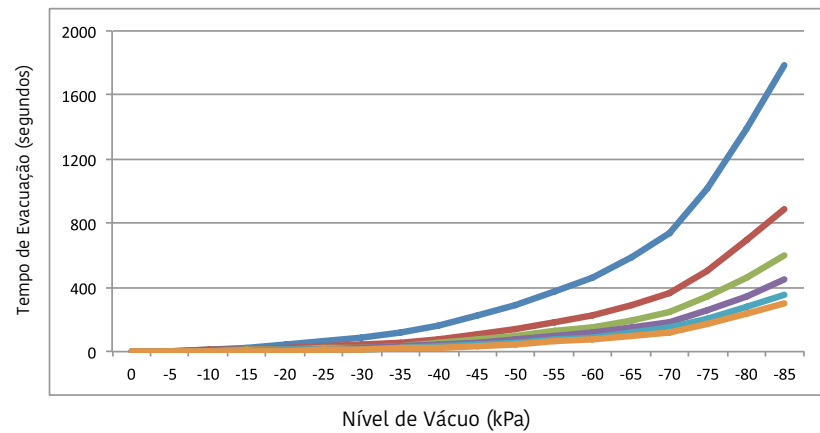

Tempo de evacuação, em segundos, para um volume de 1m³ em diferentes níveis de vácuo.

	0	-5	-10	-15	-20	-25	-30	-35	-40	-45	-50	-55	-60	-65	-70	-75	-80	-85
MS120-350-94	0	6,480	15,040	27,040	41,840	61,040	83,920	115,680	162,000	224,800	287,440	375,120	457,200	586,160	734,320	1018,080	1391,360	1786,000
MS240-700-94	0	3,240	7,520	13,520	20,920	30,520	41,960	57,840	81,000	112,400	143,720	187,560	228,600	293,080	367,160	509,040	695,680	893,000
MS360-1050-94	0	2,160	5,013	9,013	13,947	20,347	27,973	38,560	54,000	74,933	95,813	125,040	152,400	195,387	244,773	339,360	463,787	595,333
MS480-1400-94	0	1,620	3,760	6,760	10,460	15,260	20,980	28,920	40,500	56,200	71,860	93,780	114,300	146,540	183,580	254,520	347,840	446,500
MS600-1750-94	0	1,296	3,008	5,408	8,368	12,208	16,784	23,136	32,400	44,960	57,488	75,024	91,440	117,232	146,864	203,616	278,272	357,200
MS720-2100-94	0	1,080	2,507	4,507	6,973	10,173	13,987	19,280	27,000	37,467	47,907	62,520	76,200	97,693	122,387	169,680	231,893	297,667

* dados feitos sem silenciador

VAZÃO X NÍVEL DE VÁCUO

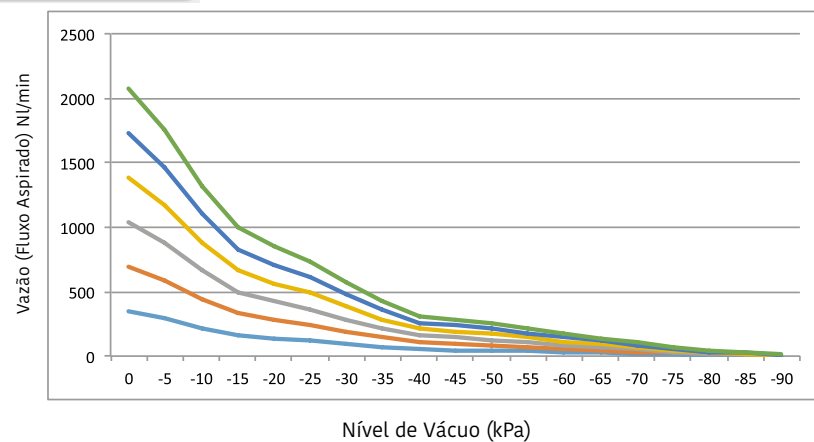

	0	-5	-10	-15	-20	-25	-30	-35	-40	-45	-50	-55	-60	-65	-70	-75	-80	-85	-90
MS120-350-94	345,0	292,5	220,0	166,0	141,0	122,0	95,5	71,5	52,0	47,5	42,5	36,0	28,5	23,0	17,0	11,0	6,5	4,5	1,5
MS240-700-94	690,0	585,0	440,0	332,0	282,0	244,0	191,0	143,0	104,0	95,0	85,0	72,0	57,0	46,0	34,0	22,0	13,0	9,0	3,0
MS360-1050-94	1035,0	877,5	660,0	498,0	423,0	366,0	286,5	214,5	156,0	142,5	127,5	108,0	85,5	69,0	51,0	33,0	19,5	13,5	4,5
MS480-1400-94	1380,0	1170,0	880,0	664,0	564,0	488,0	382,0	286,0	208,0	190,0	170,0	144,0	114,0	92,0	68,0	44,0	26,0	18,0	6,0
MS600-1750-94	1725,0	1462,5	1100,0	830,0	705,0	610,0	477,5	357,5	260,0	237,5	212,5	180,0	142,5	115,0	85,0	55,0	32,5	22,5	7,5
MS720-2100-94	2070,0	1755,0	1320,0	996,0	846,0	732,0	573,0	429,0	312,0	285,0	255,0	216,0	171,0	138,0	102,0	66,0	39,0	27,0	9,0

* dados feitos sem silenciador

Multi-ejetores de 1 à 6 ejetores

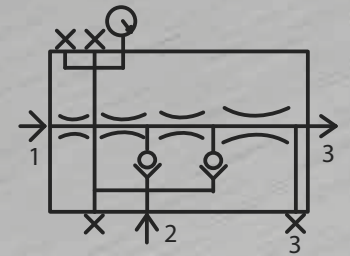

- MS120-350-94
- MS240-700-94
- MS360-1050-94
- MS480-1400-94
- MS600-1750-94
- MS720-2100-94

Especificações Técnicas

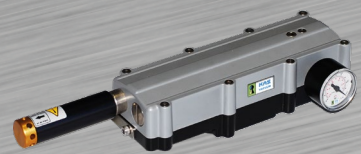

MS120-350-94



MS240-700-94



MS360-1050-94

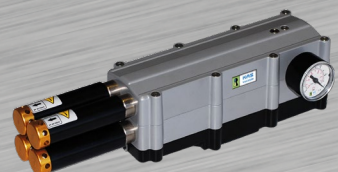

MS480-1400-94



MS600-1750-94

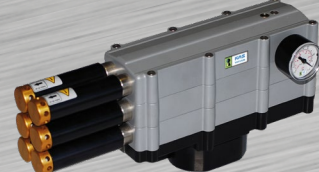

MS720-2100-94

INFORMAÇÕES

	MS120-350-94	MS240-700-94	MS360-1050-94	MS480-1400-94	MS600-1750-94	MS720-2100-94
Depressão	-92 à -94 KPa	-92 à -94 KPa	-92 à -94 KPa	-92 à -94 KPa	-92 à -94 KPa	-92 à -94 KPa
Vazão em aberto	345 NI/min	690 NI/min	1035 NI/min	1380 NI/min	1725 NI/min	2070 NI/min
Consumo de ar	120 NI/min	240 NI/min	360 NI/min	480 NI/min	600 NI/min	720 NI/min
Qualidade do ar	Filtrado 40µ isento de água e óleo	Filtrado 40µ isento de água e óleo	Filtrado 40µ isento de água e óleo	Filtrado 40µ isento de água e óleo	Filtrado 40µ isento de água e óleo	Filtrado 40µ isento de água e óleo
Pressão de Alimentação	0,4 à 0,75 MPa	0,4 à 0,75 MPa	0,4 à 0,75 MPa	0,4 à 0,75 MPa	0,4 à 0,75 MPa	0,4 à 0,75 MPa
Nível de Ruído em Operações	80 dBA	80 dBA	80 dBA	80 dBA	80 dBA	80 dBA
Temperatura de Trabalho	-20/ +65°C	-20/ +65°C	-20/ +65°C	-20/ +65°C	-20/ +65°C	-20/ +65°C
Materiais	Alum - Latão Inox - NBR	Alum - Latão Inox - NBR	Alum - Latão Inox - NBR	Alum - Latão Inox - NBR	Alum - Latão Inox - NBR	Alum - Latão Inox - NBR
Massa	1.290 g	1.370 g	1.915 g	1.995 g	2.760 g	2.840 g
Alimentação: diâmetro interno de mangueira / válvula aconselhada	≥ 4mm - ≥ 1/8"	≥ 5mm - ≥ 7/32"	≥ 6mm - ≥ 1/4"	≥ 7mm - ≥ 5/16"	≥ 9mm - ≥ 3/8"	≥ 10mm - ≥ 3/8"
Saída de vácuo: diâmetro interno da mangueira / válvula aconselhada / distribuidor	≥ 12mm - ≥ 1/2"	≥ 16mm - ≥ 5/8"	≥ 19mm - ≥ 3/4"	≥ 25mm - ≥ 1"	≥ 38,1mm - ≥ 1,1/2"	≥ 38,1mm - ≥ 1,1/2"

VANTAGENS

- Silenciosa
- Compacta
- Endotérmica, retira calor do ambiente
- Escalabilidade, possibilidade de exclusão ou inclusão de ejetores caso haja necessidade e disponibilidade no corpo da bomba
- Uma das melhores relações entre consumo de ar e fluxo de vácuo do mercado
- Podem operar em processos não contínuos, sendo ligadas e desligadas inúmeras vezes em frequências altas
- Opera em temperaturas de até 150°C (quando solicitada com vedações em Viton®)

Viton® é a marca registrada da DuPont Performance Elastomers

Dimensões - Montagem Longitudinal

MS120-350-94

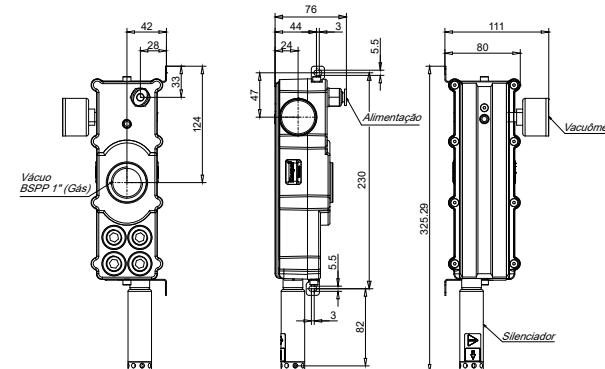

MS240-700-94

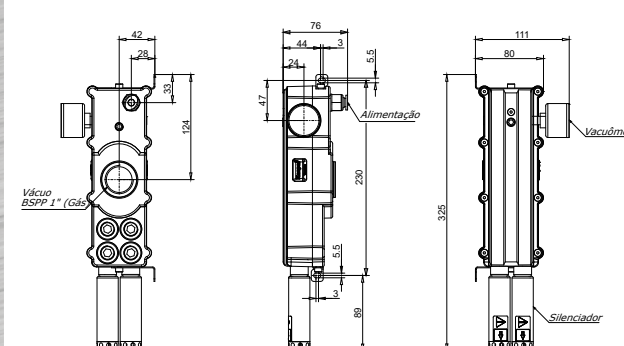

MS360-1050-94

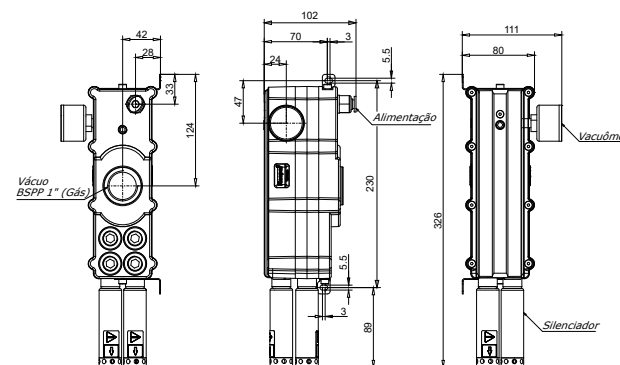

MS480-1400-94

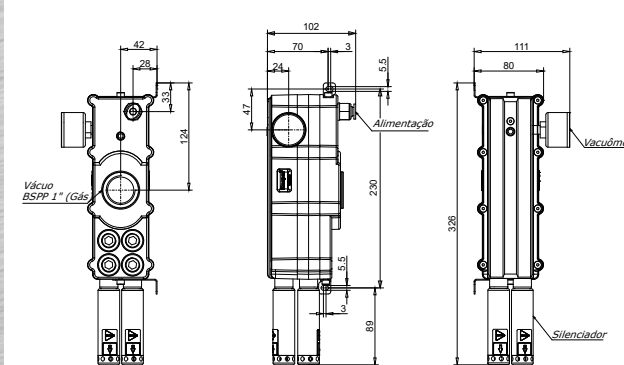

MS600-1750-94

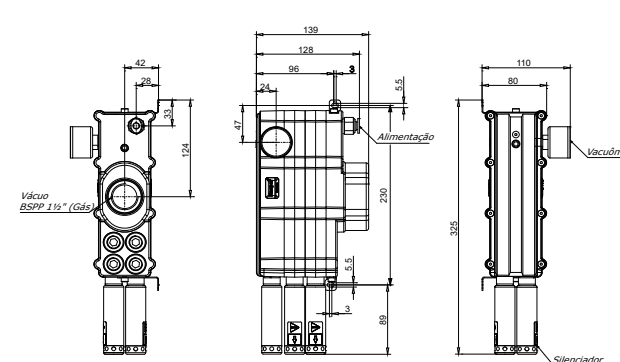

MS720-2100-94

